

2/3-monthly Report

TANG Zhiyuan

3.9.2015-3.31.2015

2,000,000 s

vs.

a piece of paper barely

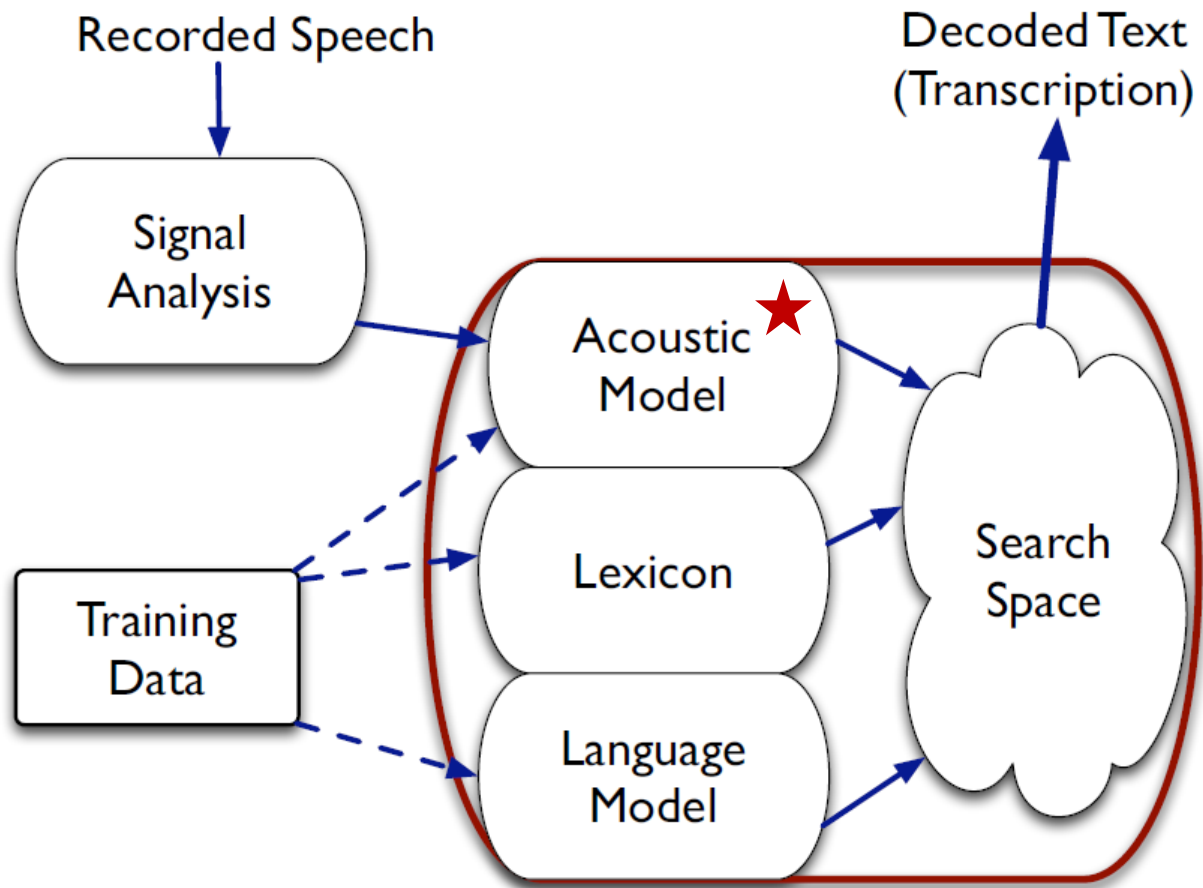

Along with **Kaldi**

MFCC
CMN
LDA
MLLT
...

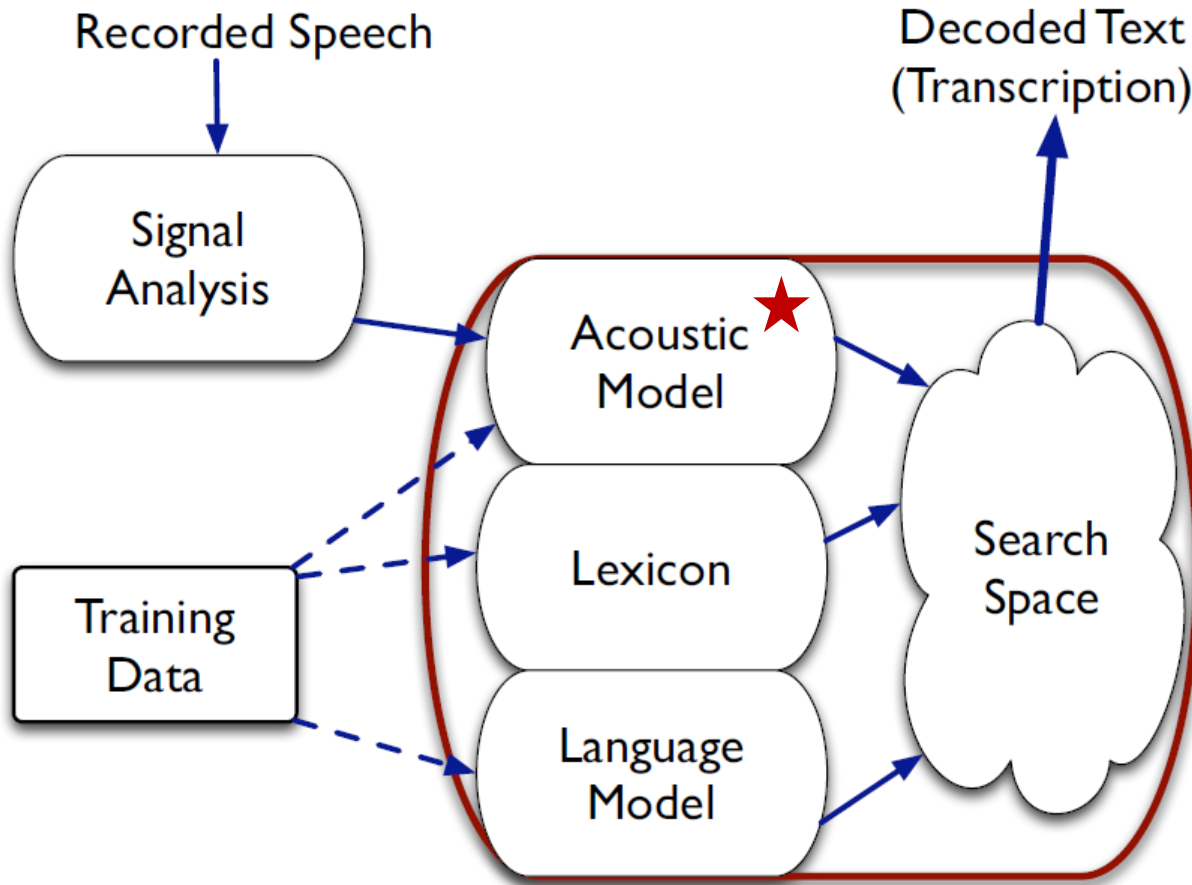

N-gram
...

Along with **Kaldi**

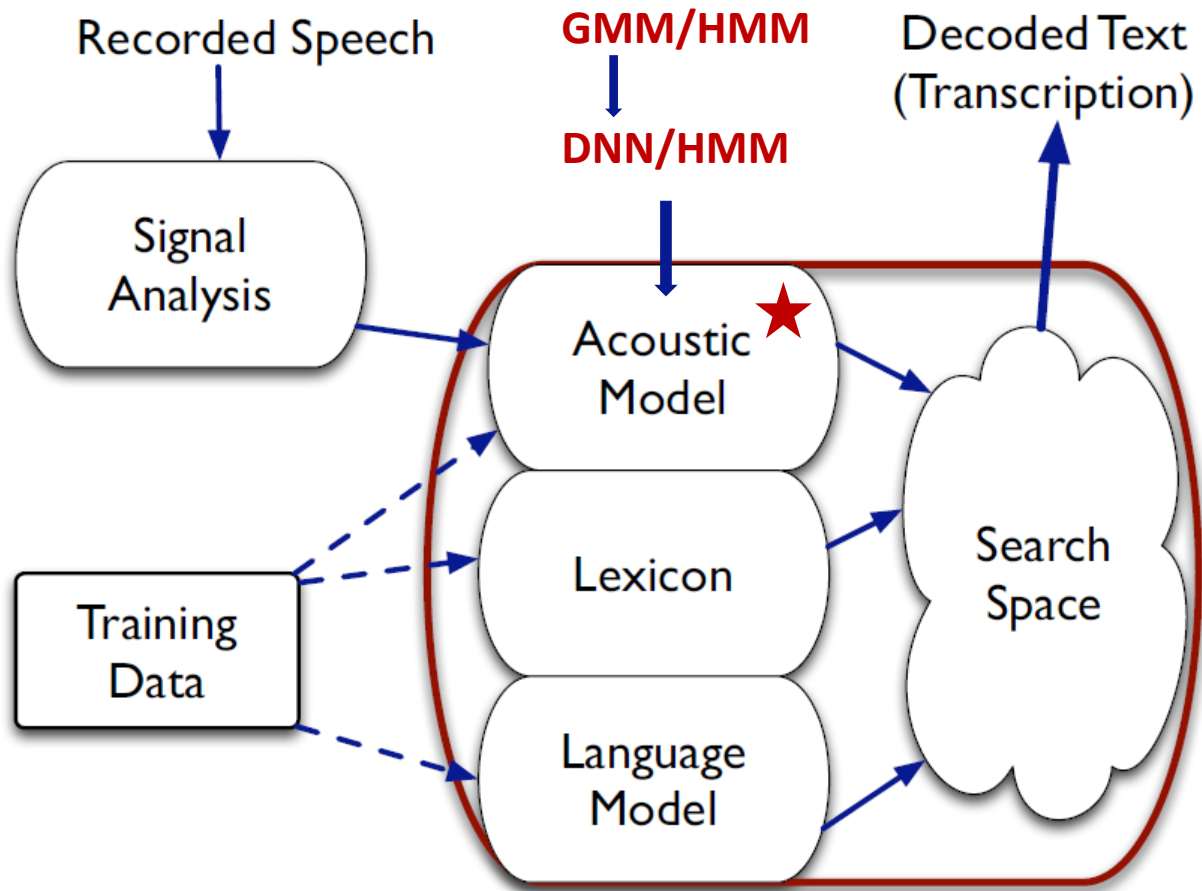

Along with **Kaldi**

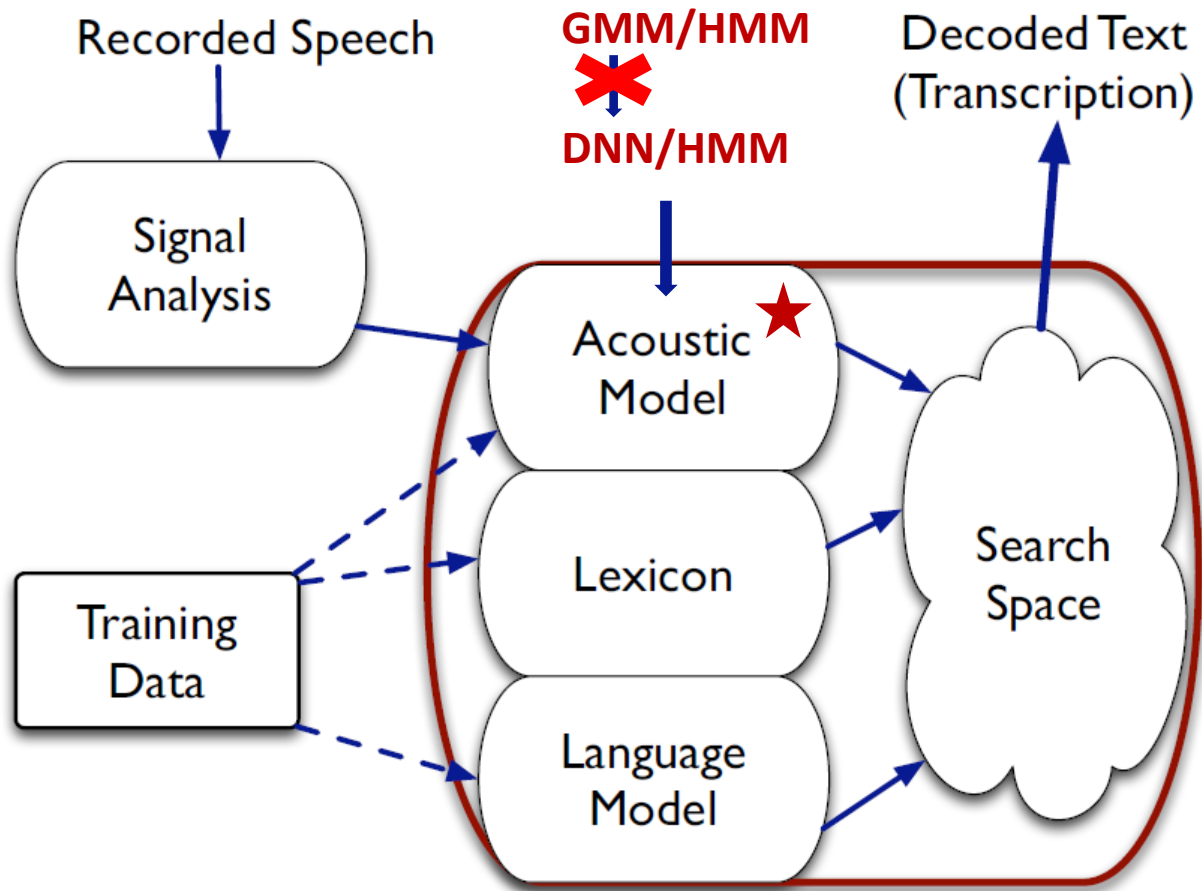

Along with **Kaldi**

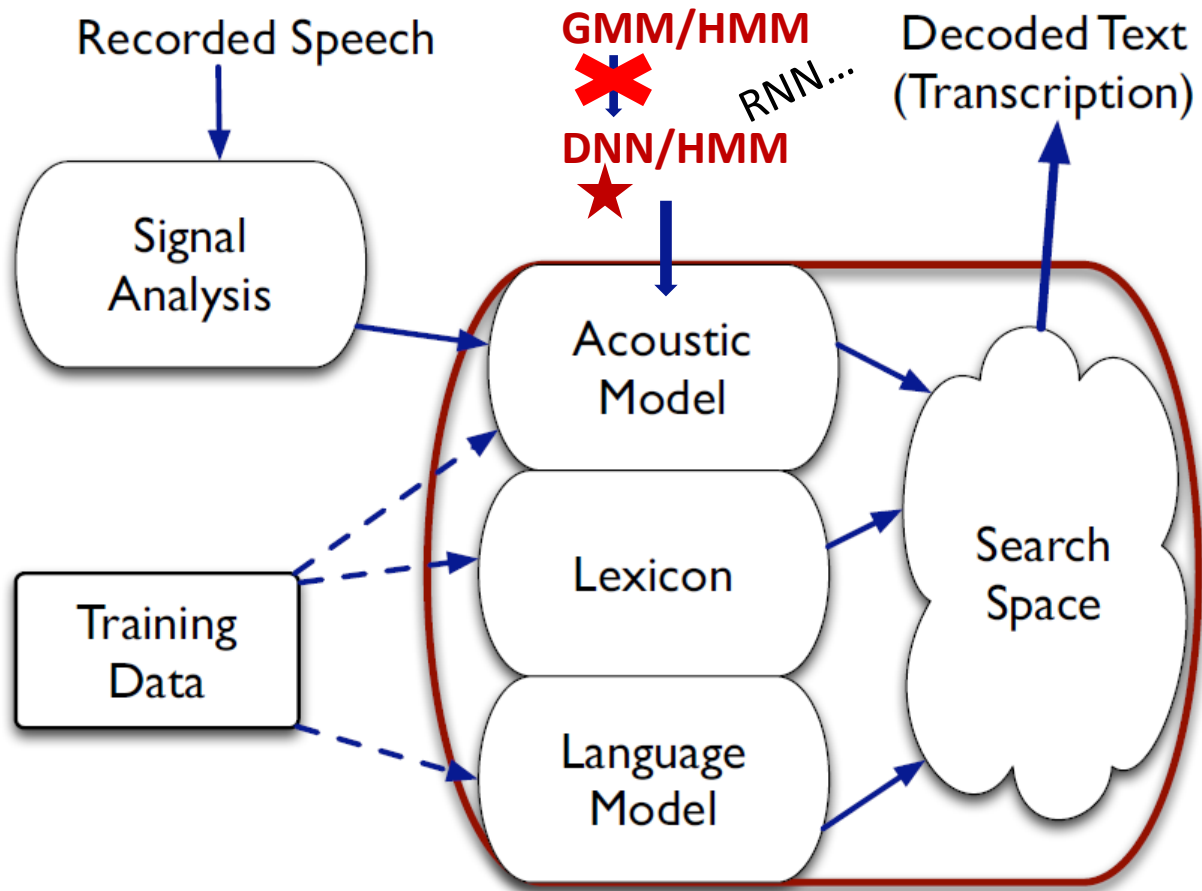

Along with **Kaldi**

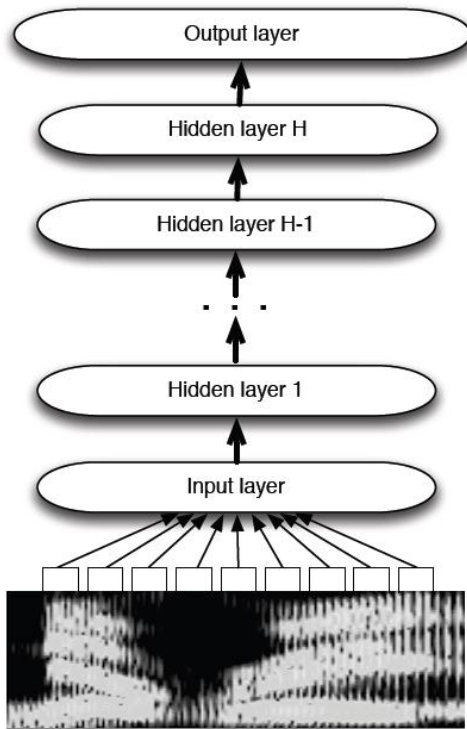

VS.

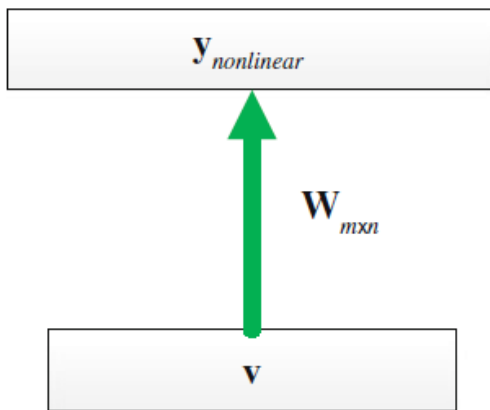
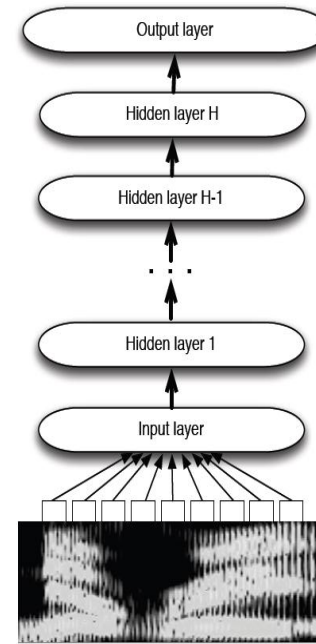

$m \times n$

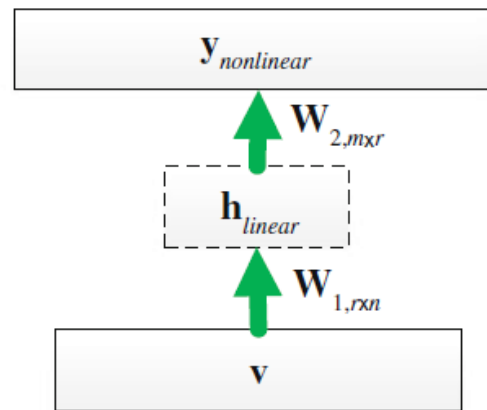

$(m+n) \times h$

Realize Sparseness:
 Regularization;
 constraint optimization;
 OBD;
 ...

Quiz

How much does it weigh for a sound speech/language system if computation power could be weighed?

Quiz

How much does it weigh for a sound speech/language system if computation power could be weighed?

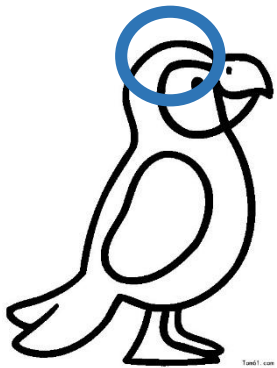

Quiz

How much does it weigh for a sound speech/language system if computation power could be weighed?

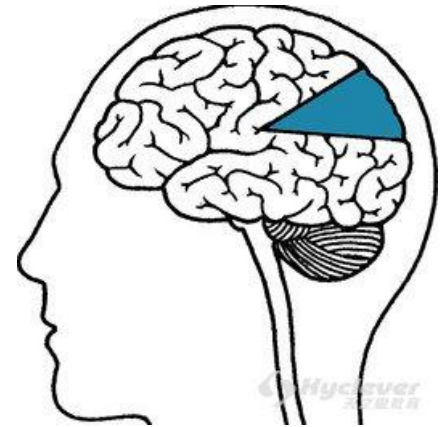
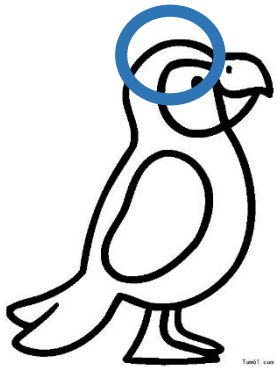

Quiz

How much does it weigh for a sound speech/language system if computation power could be weighed?

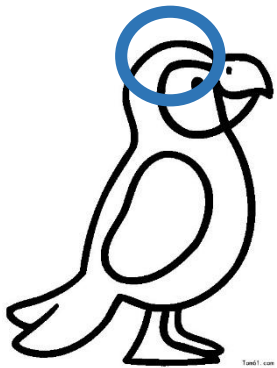

<



<

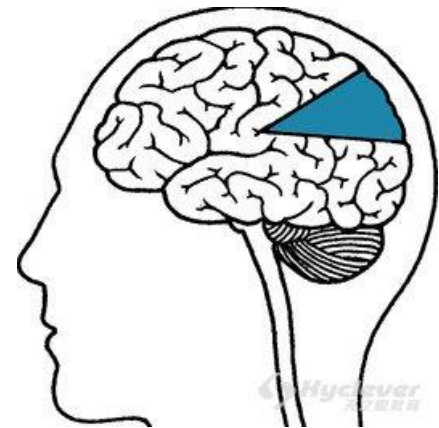

大智若愚人

大智若愚~~人节~~快乐！

TKS.